

CUTTING OUT LETTERS – Working With Symmetry

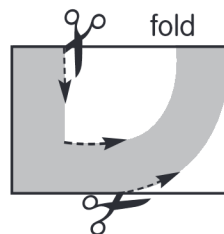

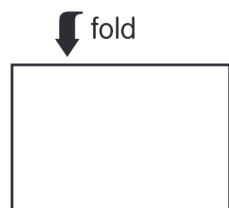

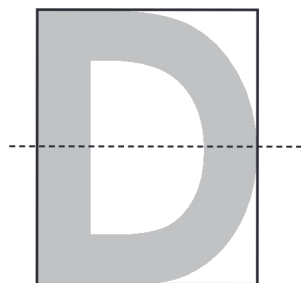

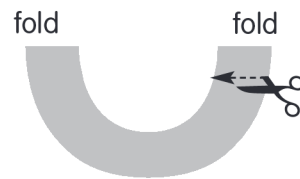
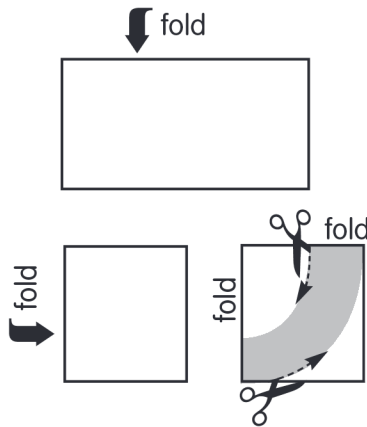
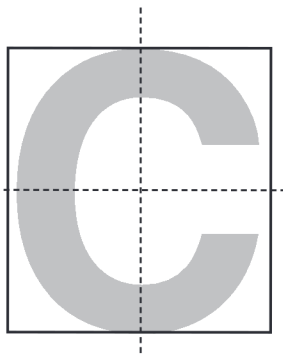
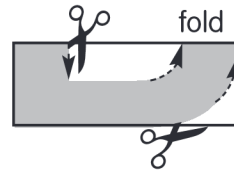
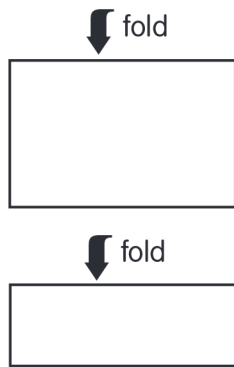
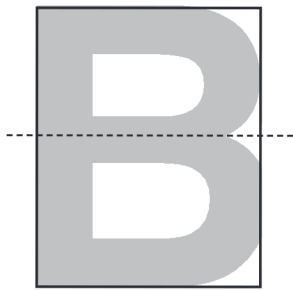
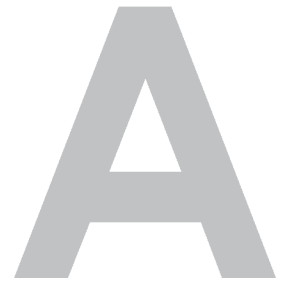
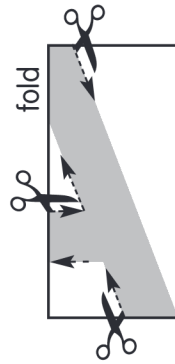
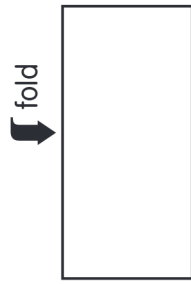
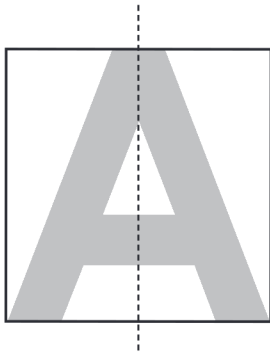
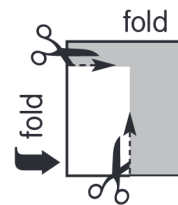
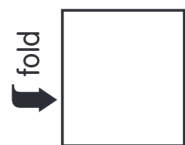
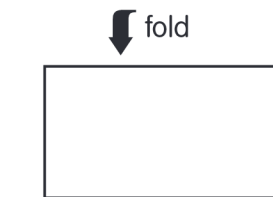
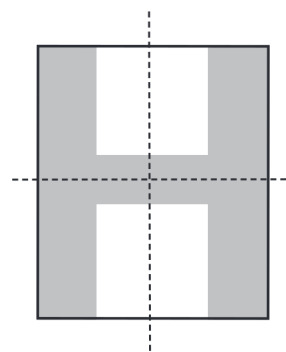
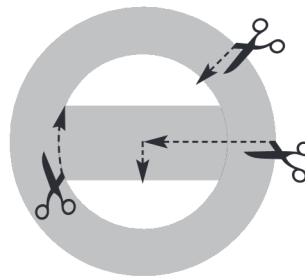
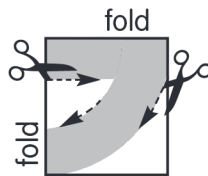
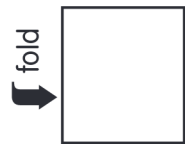
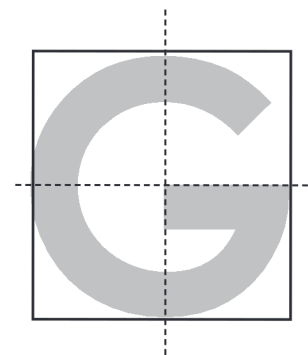
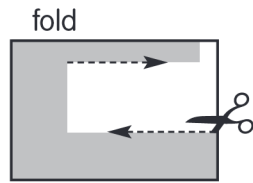
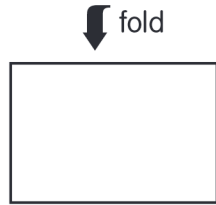
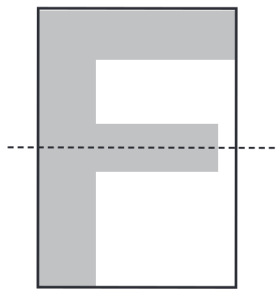
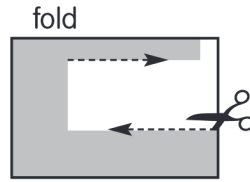
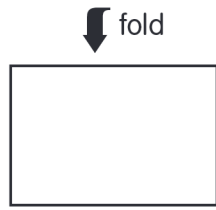
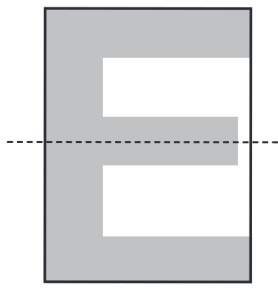
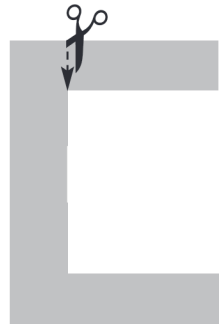
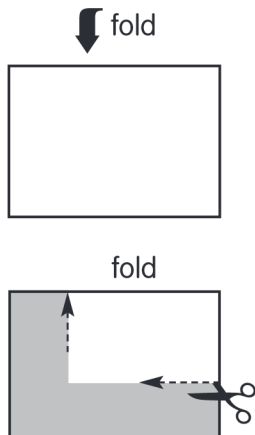
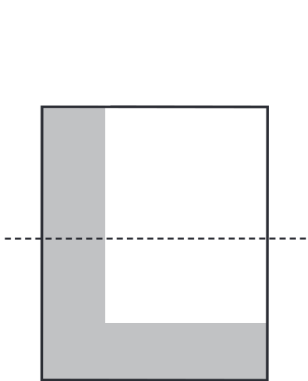
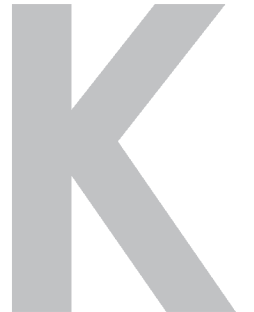
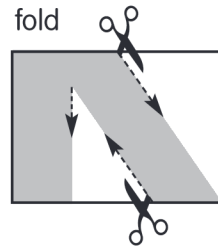
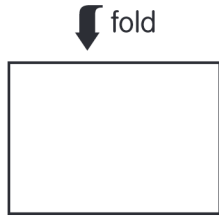
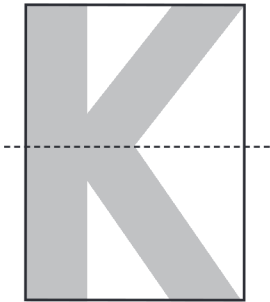
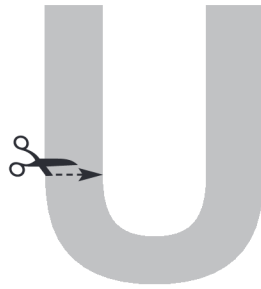
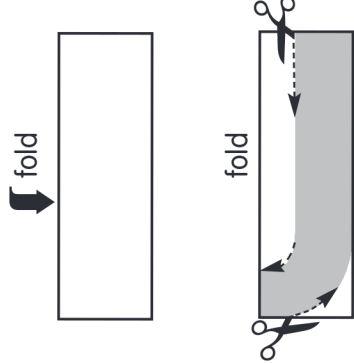
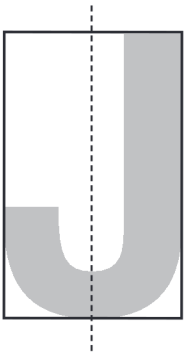
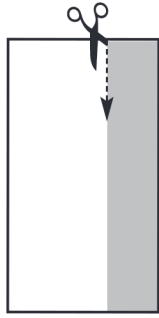
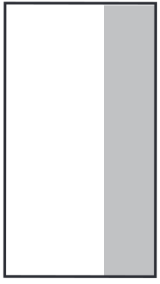
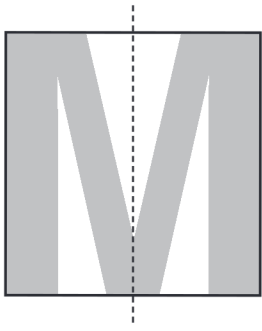

fold

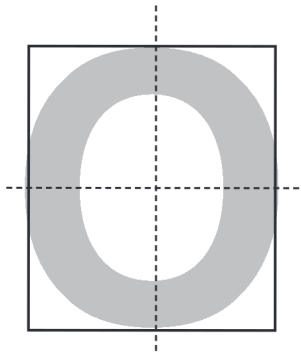
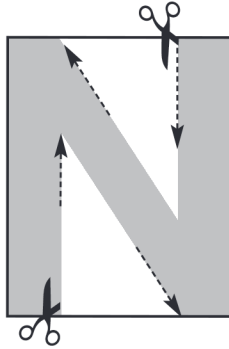
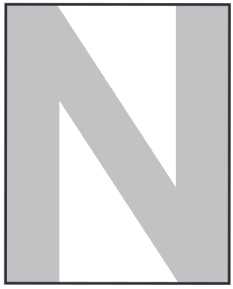
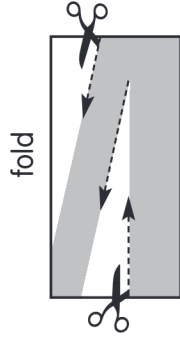

fold



fold

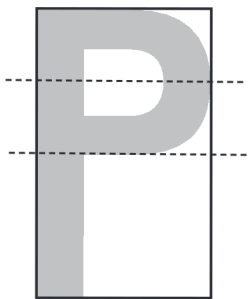
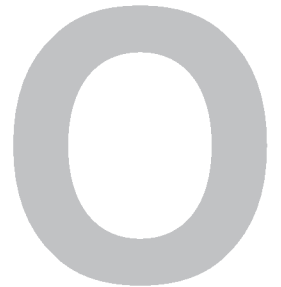
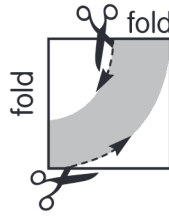
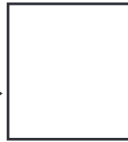

fold

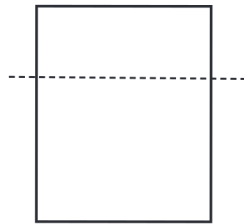

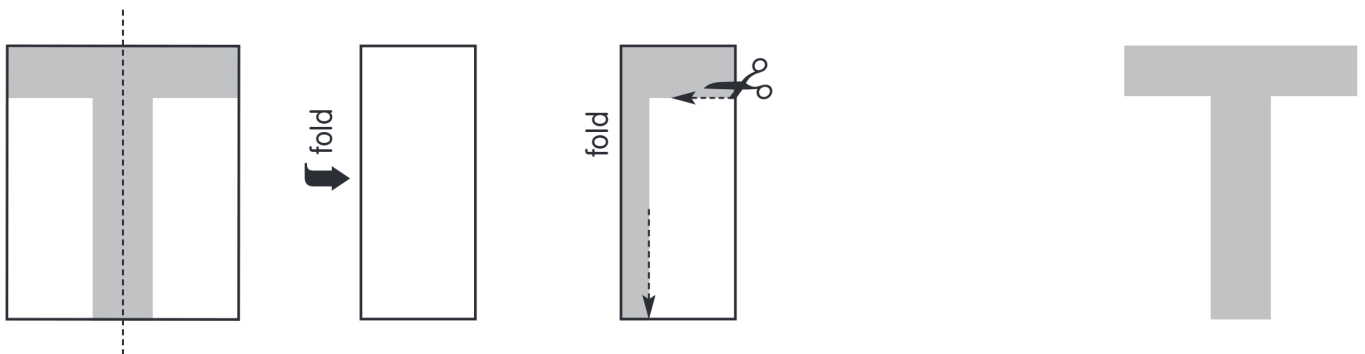
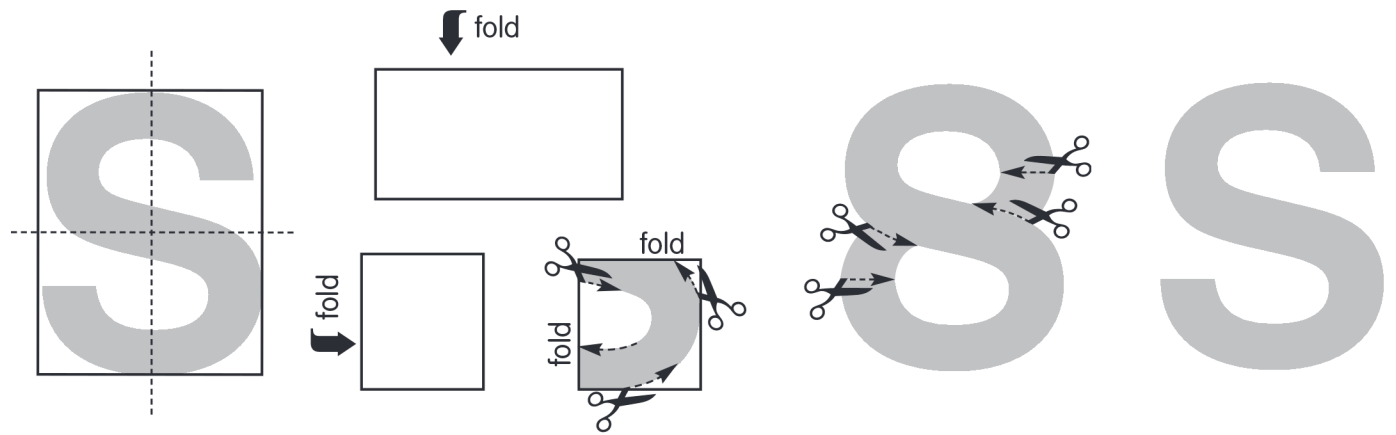
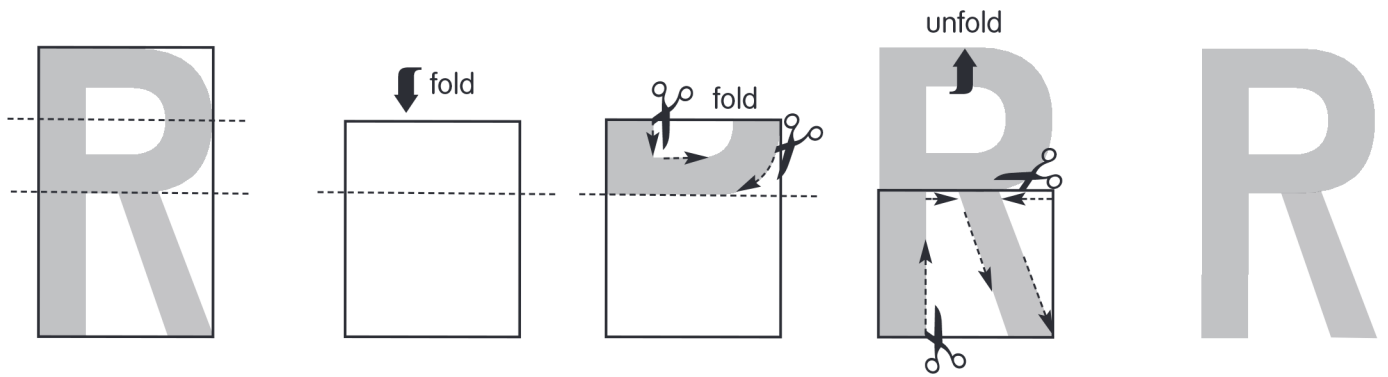
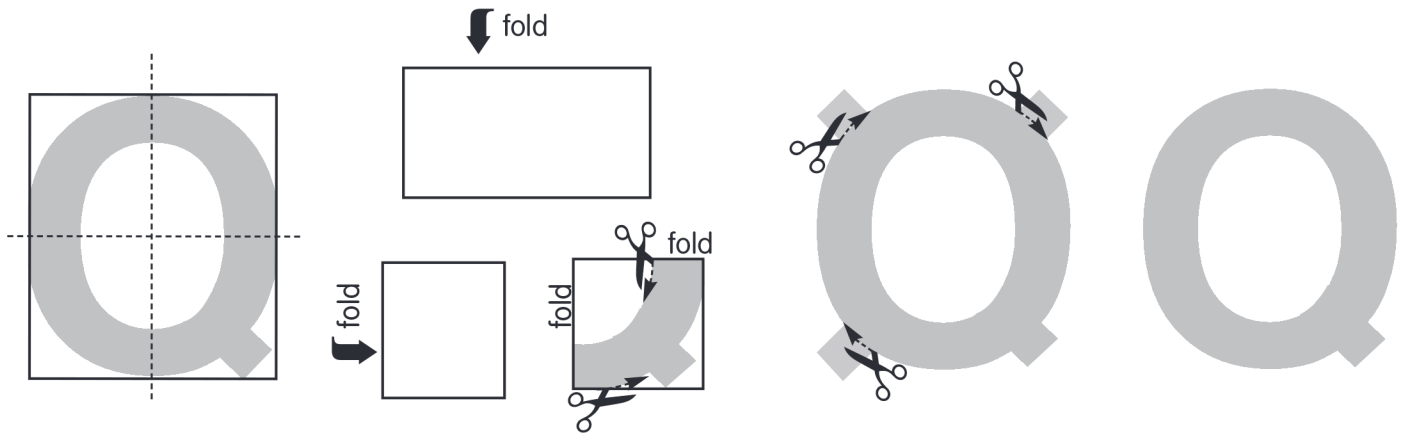

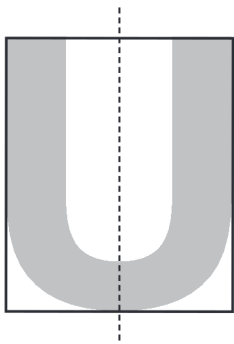

fold

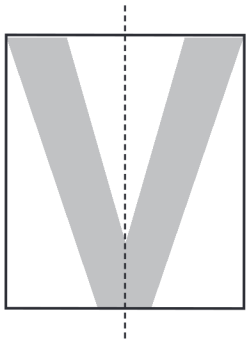
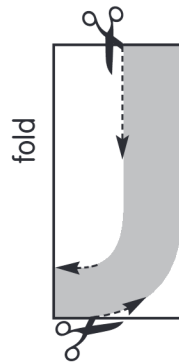

fold

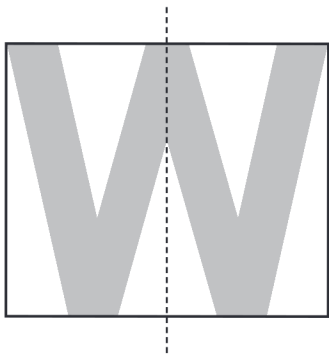
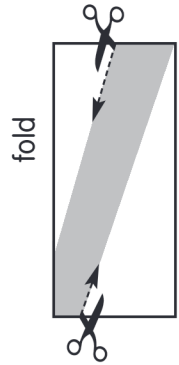

fold

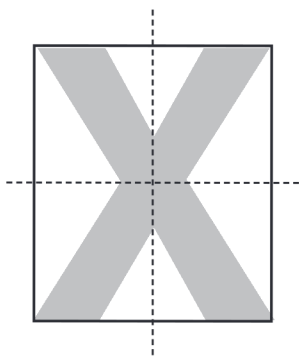
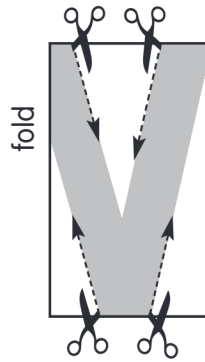

fold



fold

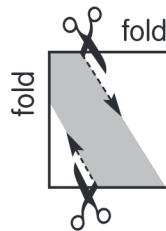

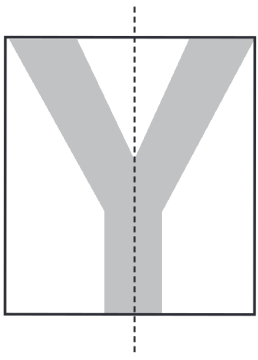

fold

